

## Flush or Recessed Rubber Bead



Measure clear glass width and drop

- min. width: 325mm
- max. width: 1400mm
- max. drop: 2000mm type 1 fabrics
- max. drop: 1700mm type 2 fabrics
- max. area: 2 sq m

## Proud Rubber Bead



measuring the window

**A**

## Tape Measure



## Depth Gauge (TP487)



- max. Bead Depth 27mm
- min. Bead Depth 11mm

bead depth

**B**

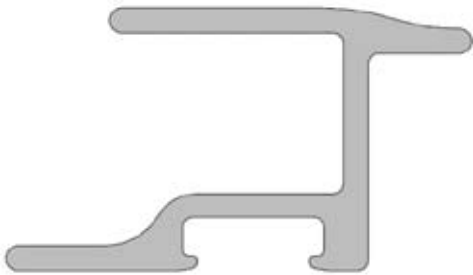

Side Extrusion: standard

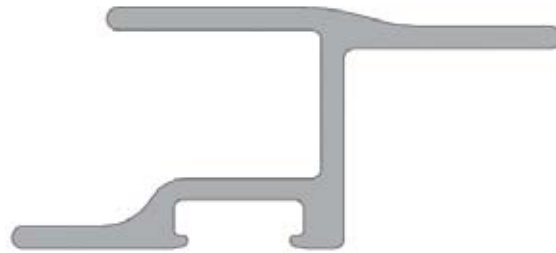

Side Extrusion: large

side profile

**C**

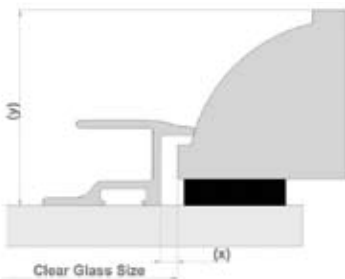

Select side extrusion that gives smallest gap between extrusion and window bead (x)

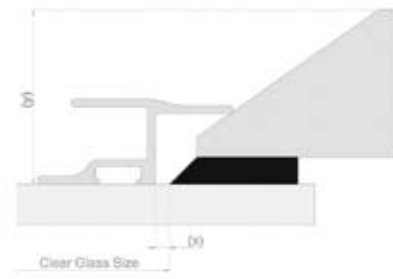

best fit profile

**D**

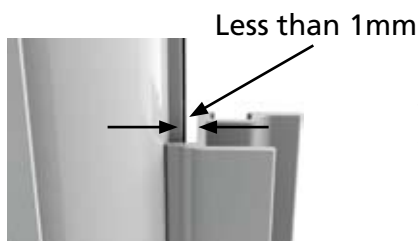

Less than 1mm

Where the gap is greater than 1mm. This size MUST BE deducted from clear glass size (Both sides!)

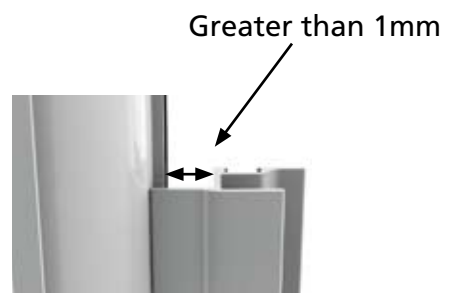

Greater than 1mm

best fit

**E**

F

special headrail

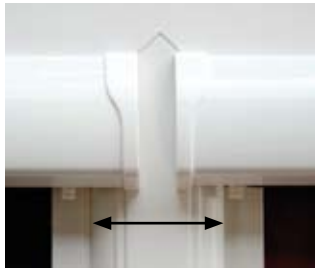

70mm std.  
50mm mod.

### Reduced Headrail

- insufficient clearance on window frame or glazing bar will require modified headrails
- reduction will be 10mm per side
- note requirements on order form in 'Special Instructions' box

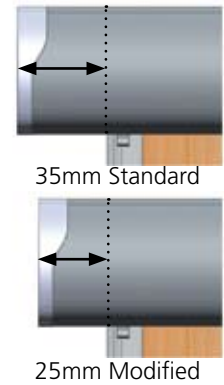

G

air vents

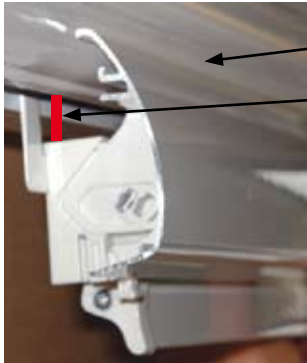

vent  
measure here (y)

### Air Vents

When headrail may foul air vent or other obstruction, a deduction of up to 10mm can be made from the clear glass size (drop). This can be measured by using a small section of headrail fascia fitted with a fixing bracket.

**Enter drop (a) on order form (x-y=a)**

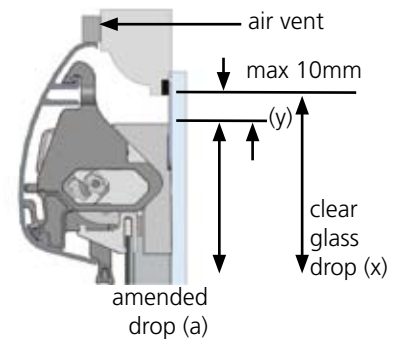

H

bottom bar



### Bottom Bar

When installation is complete, clearance between bottom bar endcap and side extrusion should be checked. This should be parallel along entire length of side extrusion. This can be checked by holding bottom bar tight against one side and measuring the clearance on the opposite side.

Max. clearance: 3mm

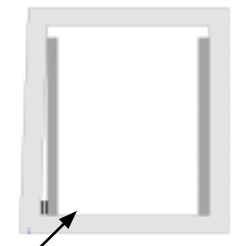

When window is slightly out of square, spacer pads should be used to ensure side extrusions run parallel.

I

fabric alignment



### Fabric Alignment

Blind should be checked when installation is complete to ensure that fabric is rolling up parallel. Where this is not the case the blind can be adjusted by moving one side extrusion up or down within the ratchet lock area. This will in turn induce the fabric to roll to one side as required. e.g. If fabric is rolling off to left hand side, lower right hand corner bracket. This can be done by releasing the side extrusion locking bracket from the ratchet lock, slide corner bracket down, lock side extrusion back in to ratchet lock.

J

headrail lock



Blind unlocked

### Headrail Lock

After installation ensure that headrail locking arm is fully engaged. This can be checked by looking from below to ensure locking arm is sitting parallel with mating bracket.

It is important to ensure that blind is always left in the locked position.



Blind locked