

Flush or Recessed Rubber Bead



Measure clear glass width and drop

- min. width: 240mm
- max. width: 1400mm
- max. drop: 2000mm
- max. area: 1.5 sq m

Proud Rubber Bead

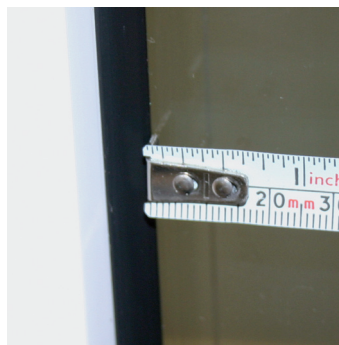

measuring the window

A

Tape Measure



Depth Gauge (TP487)



For beads above 27mm use INTU® Screwfit

- bead depth 19 to 27mm: no endcap spacer
- bead depth 15 to 18mm: 1 endcap spacer per side
- bead depth 11 to 14mm: 2 endcap spacers per side
- min. bead depth: 11mm

bead depth

B

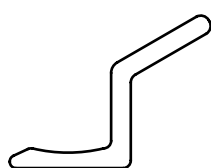

Profile A



Profile B

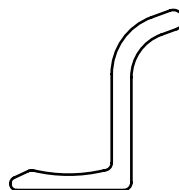

Profile C



Profile D

All profiles are shown at 2x actual size

side profile

C

Flush or Recessed Rubber Bead

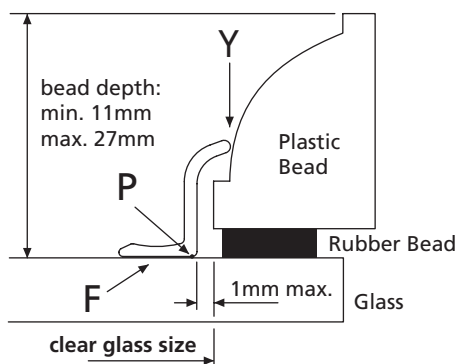

Select side profile that:-

- gives best fit at Y,
- has max. 1mm gap between point P and clear glass size,
- keeps face F flat on glass

Proud Rubber Bead

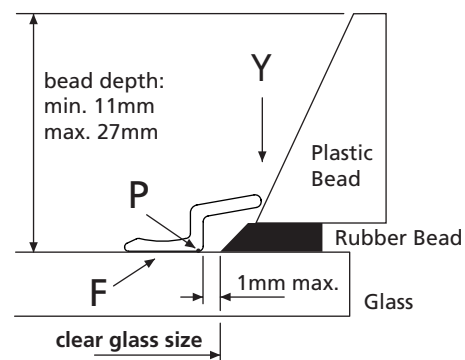

rubber bead

D

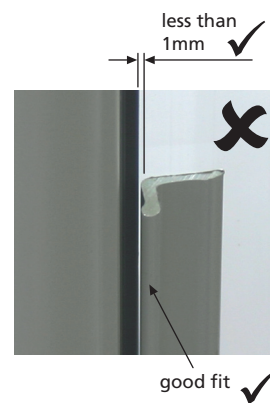
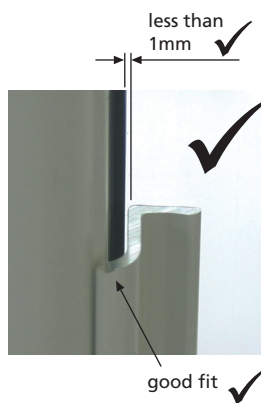
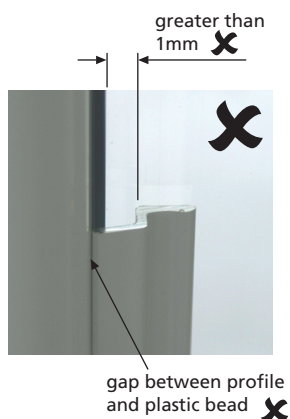
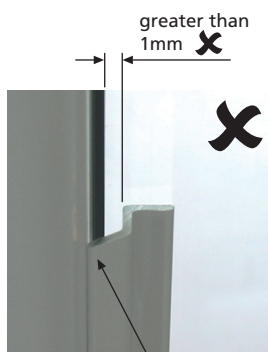

best fit profile

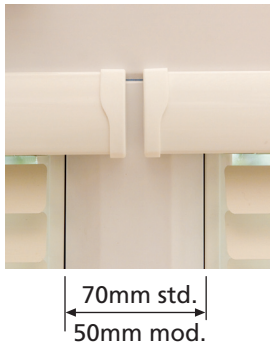
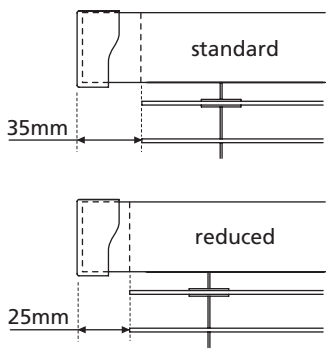

E

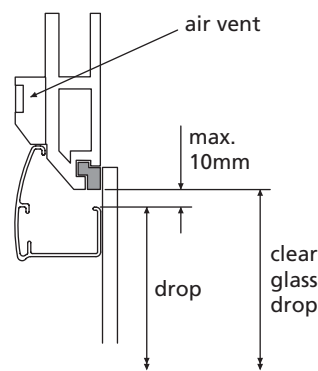
F	special headrail		<p>Reduced Headrail — All Models</p> <ul style="list-style-type: none"> insufficient clearance on window frame or glazing bar will require modified headrails reduction will be 10mm per side note requirements on order form 'Special Instructions' box 	
---	------------------	--	--	---

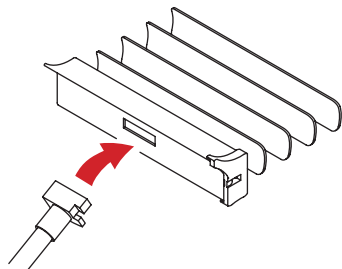
G	air vents		<p>Air Vents</p> <p>When headrail may foul air vent or other obstruction, a deduction of up to 10mm can be made from the clear glass drop to clear obstruction</p>	
---	-----------	---	---	---

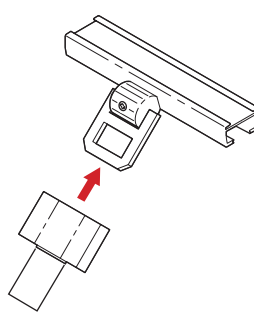
H	operating rod		<p>Blind Out of Reach — All Models (for Multizone & Bottom up see below)</p> <ul style="list-style-type: none"> choose 30 or 60cm rod as required the rod connector is placed inside the tilt handle (Venetian only) bottom rail is slotted for raising/lowering 	
---	---------------	--	--	--

I	operating rod		<p>Blind Out of Reach — Multizone & Bottom Up only</p> <ul style="list-style-type: none"> on Multizone or Bottom Up blinds a 'Twistlock handle' is fitted to the centre of the bottomrail. operating rod (PH135) fitted with matching 'Twistlock' connector is supplied. Suggested to order 1 per installation push rod connector over handle and rotate rod clockwise (requires about 30 degrees rotation) rod is now locked on rail raise/lower as required rotate rod anticlockwise to release 	
---	---------------	---	--	--

J	multizone	 <p>Bottomrail with integrated handle</p>	<p>All blinds are supplied with bottomrail that has an integrated handle. However, if the 'Multizone' or 'Bottom Up' option is selected on the Pleated/Cellular Fax Back Order Form, the rail will use screw in handles.</p>	 <p>Bottomrail with screw in handle</p>
---	-----------	--	--	--